

# **RONGTA** User Manual

---

## **58MM THERMAL RECEIPT PRINTER ACE G1Y**

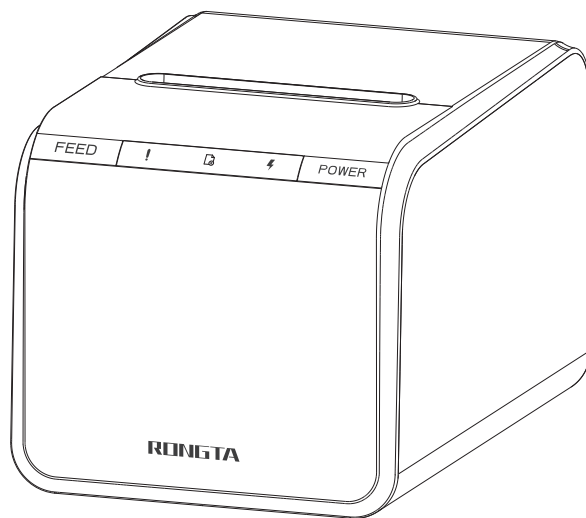

# Contents

---

---

I. Product Introduction.....	2
1.1 Safety Warnings.....	2
1.2 Main Features.....	2
II. Safety Instructions.....	3
III. Appearance and Components.....	4
IV. Technical Parameters.....	5
4.1 Printing Parameters.....	5
4.2 Printer Indicators.....	6
4.3 Printer Interfaces.....	6
V. Installation and Operation of Printer.....	7
5.1 Printer Unpacking.....	7
5.2 Connecting the Printer.....	7
5.3 Loading Paper.....	8
VI. The Switch, Key and Indicator Light of Printer.....	9
6.1 Power Switch.....	9
6.2 Keys and Indicators.....	9
6.3 Self-Test of Printer.....	10
6.4 Special Functions of Printer.....	10
VII. Serial Interfaces of Printers.....	12
VIII. Ethernet Interfaces of Printers.....	13
IX. Cashbox Interfaces of Printers.....	14
X. Cleaning the Printer.....	15
10.1 Cleaning the Printer Head.....	15
10.2 Cleaning the Sensor.....	15
10.3 Cleaning the Printing Rubber Roller.....	16
XI. Release the Jammed Knife.....	17
XII. Troubleshooting.....	17
XIII. Driver Installation .....	18
13.1 Installation for Windows.....	18
13.2 The Port Direct Drive.....	18

# I. Product Introduction

---

---

Thank you for purchasing the ACE G1Y series thermal receipt printer produced by our company. This thermal receipt printer provides you with safe, reliable and efficient printing quality at a reasonable economic price. At the same time, ACE G1Y series is widely used in supermarkets, hospitals, restaurants, banks, gas stations, road and bridge toll collection and other fields due to its super functions and easy operation.

## 1.1 Safety Warnings

- ⚠ Warning:** Do not touch the paper cutting knife or paper-tearing knife of the printer.
- ⚠ Warning:** The print head is a heating component. Do not touch the print head and its surrounding components when the printer is still warm in temperature.
- ⚠ Warning:** Do not touch the surface of the thermal print head and connectors, to avoid electrostatic damage to the print head.
- ⚠ Warning:** This product is only suitable for the use in non-tropical climates.

### Warning

It is a class A product. In the living environment, this product may cause radio interference. In this case, users may need to take practical measures against its interference.

## 1.2 Main Features

- High printing quality
- Low noise
- Support cashbox drive
- The attractive appearance
- Reasonable structure, simple use and maintenance
- Built-in data buffer that receives print data when printing
- Support USB port, serial port (RS\_232), parallel port, WIFI, Ethernet port and cashbox interface (subject to actual model interface)
- The characters can be enlarged, bolded, underlined. And it can adjust the line spacing and the left-right spacing for printing.
- Realize high-speed printing equivalent to calling built-in and cartridge font in the mode of driver printing (dot map)
- Low power consumption and low operation cost (color tape and ink cartridge are not required)
- It is compatible with ESC/POS print instruction set

## II. Safety Instructions

---

---

**Before operating and using the printer, please carefully read the following items and strictly observe the use rules.**

- ① Please install the printer on a stable surface to avoid printer suffered from any vibration and shocks.
- ② Stop using keeping the product in any case of unusual circumstances such as the presence of high temperature, high humidity and serious pollution.
- ③ Connect the printer's power adapter to an appropriate grounding socket. Avoid using the same socket with large motors or other equipment that may cause voltage fluctuation of power supply.
- ④ Do not get the product wet. Do not insert foreign objects(e.g. metal) into the product, and once it occurs, immediately turn off the power supply.
- ⑤ Never use the printer without paper, otherwise it will seriously damage the printing rubber roller and thermal head.
- ⑥ Unplug the product from the power outlet if the printer is idle for a long time.
- ⑦ Do not disassemble or modify the product personally.
- ⑧ Use only the power adapter specified in this instruction.
- ⑨ In order to ensure the printing quality and prolong the service life of the product, it is recommended to use the recommended or equivalent thermal printing paper.
- ⑩ Do not plug/unplug the product with the product powered on.
- ⑪ When plugging and unplugging the printer power cord, please hold the arrow position of the printer power connector with your hand, not the cord of the printer power cord.
- ⑫ Please keep this manual for the future use and reference.

# III. Appearance and Components

## □ Front View

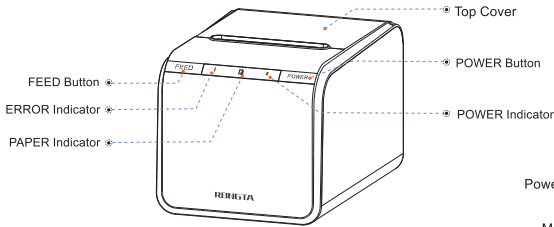

## □ Rear View

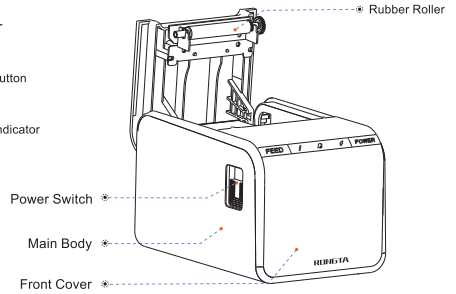

## □ Inside View

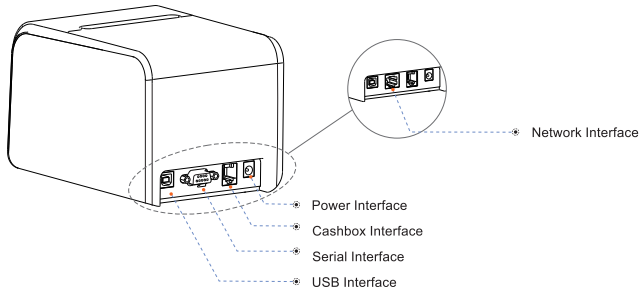

## Application Field

- Cashier system of places of entertainment
- Cashier system of retail monopoly
- Catering cashier system
- Wireless Bluetooth printing cashier system
- Postal logistics receipt printing system
- Hotel receipt printing system

## IV. Technical Parameters

### 4.1 Printing Parameters

Model	ACE G1Y
Printing method	Thermal line printer
Printing speed	150mm/s
Printing paper width	57.5±0.5 mm
Effective resolution	203 dpi ( 8 dot/mm)
Outside diameter of paper rolo	Φ65mm(MAX)
Thickness of printing paper	0.06-0.08mm
Effective printing width	48mm
Dot density	384dot/line
Character size	ASCII Font A: 12x24 ASCII Font B: 9x17 Chinese character 24x24
Line space	3.75mm(Use the command to adjust the line space)
Size of receive buffer	2KBytes
<b>Print character</b>	
ASCII character set	12x24 dot, 1.25 (width)X3.00 (height)mm
National Standard Class I and II Chinese Character Font	24x24 dot, 3.00 (width)X3.00 (height)mm
Type of bar code	One-dimensional code : UPC-A,UPC-E,EAN-13,EAN-8,CODE39,ITF,CODEBAR,CODE93,CODE128 QR code : QRCODE
Extended character table	PC437、Katakana、PC850、PC860、PC863、PC865、WPC1252、PC866、PC852、PC858 etc., 50 international languages in total
<b>Power supply</b>	
Power adapter	AC 100 ~ 240V
Input power supply	DC 24V 2.5A
Cashbox output	DC 24V 1A
<b>Service life</b>	
Service life	The service life of print head: 150 kilometers; The service life of inner diffusion knife: one million times
<b>Environmental requirements</b>	
Working environment	Operating temperature: 0~45°C, operating humidity: 20~90%
Storage environment	Storage temperature: -10~60°C, storage humidity: 10~90%
<b>Environmental conditions</b>	
Drive	WIN2003/WINXP/WIN7/WIN8/WIN10
Print command	ESC/POS/command compatible
Dimensions	168x120x113mm

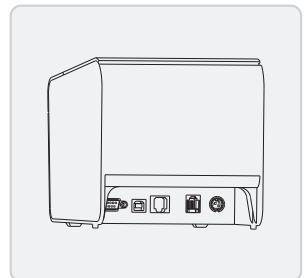
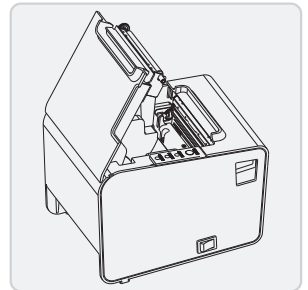





The pictures are for reference only, please subject to practicality

## 4.2 Printer Indicators

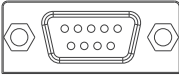
<b>Type of printing paper</b> Thermal paper rolls recommended	Thermal printing paper
<b>Type of paper rolls</b>	Specifications: AF50KS-E Manufacturer: Jujo Thermal Oy(Finland) Specifications: TF-50KS-E Manufacturer: Nippon Paper Industries Co., Ltd  <b>⚠ Attention</b> (1) To get the best results from the printer, choose the recommended paper or other paper with equivalent quality, otherwise the printing quality will be affected and even the service life of thermal print head will be reduced. (2) Please do not use the paper roll that the end glued on the core of the paper roll, otherwise it may cause damage to the printer. (3) If the printing paper is contaminated by chemicals or oils, it may fade or reduce the sensible heat degree, and affect the printing effect. (4) Do not rub the surface of the printing paper with hard articles, otherwise it may cause fading. (5) The print paper will fade if the temperature is up to 70°C, keep it out of direct sunlight, humidity and high temperature.

## 4.3 Printer Interfaces

Diagram	Type	Illustration
	USB	Universal USB Interface (Standard Type B)
	Serial interface	Db9 female connector interface, communication baud rate is 9600bps,19200bps, 38400bps or 115200bps optional (adjusting via DIP switch), data structure is parity-free, 8-bit data bit, 1-bit stop bit; RTS/CTS and XON/XOFF handshake protocols are supported
	Network interface	Standard RJ45-8P interface, 10M/100M transmission speed with self-adaptation, 100M network LED indication, data communication LED indication.
	Cashbox control	The 6-wire RJ-11 socket, outputting DC 12V/1A power signal to drive the cashbox.
	Power interface	Power plug DC 9V.





Ⓞ **Note:** The interface is optional or customized, and the specific interface is subject to the actual object.

# V. Installation and Operation of Printer

## 5.1 Printer Unpacking

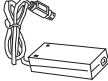
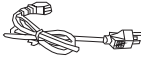
### Check the parts:

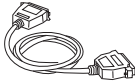
Before use, make sure the accessories are included in the package(the following picture is an example). If any thing is missing, contact the supplier or manufacturer. The specific accessories may not be included depending on the printer model.

 Main machine	 Power adapter	 Power cord	 Paper roll
 Communication cable	 USB cable	 Quick installation guide	

☺ The pictures are for reference only, please subject to practicality.

## 5.2 Connecting the Printer

- (1) Make sure that both the printer and the PC host are turned off, plug the matching data communication cable into the printer's data interface, and plug the other end into the serial port/parallel port /USB/ network port of PC host.
- (2) If equipped with an electrically openable cashbox, insert the RJ-11 connector on the cashbox into the cashbox interface of the printer (the specifications of the cashbox must conform to the printer cashbox drive specifications).
- (3) Connect to the special power adapter of the printer.

**Use the special power adapter for the printer.**

**The connection diagram is as follows:**

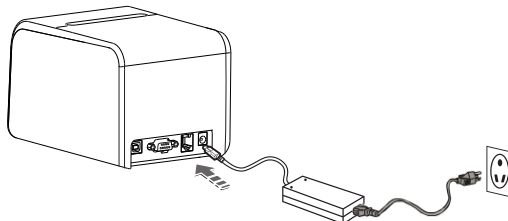



## Attention:

- (1) First plug the power plug DC24V of the printer, then switch on the AC220V power supply, and then turn on the power switch. Do not reverse the sequence, otherwise the machine will be damaged.
- (2) Using an improper power adapter will make the printing quality worse and even damage the printer.
- (3) Do not connect the telephone line to the cashbox interface, otherwise the printer and telephone may be damaged.
- (4) When plugging in the printer power cord, please hold the arrow position of the printer power connector with your hand (do not plug in the cord of the printer power cord with your hand). Forcibly plucking the flexible cord of the printer power connector or pulling the printer power cord may cause damage to the printer or the power adapter.

## 5.3 Loading Paper

The ACE G1Y series thermal receipt printer uses 58mm thermal paper rolls and adopts an easy paper loading mechanism, which is very convenient for paper loading.

### The Installation Method of Thermal Paper is as Follows:

- (1) Open the upper cover of the printer.
- (2) Insert the roll paper as shown in the 1 illustration.
- (3) Pull out a part of paper, and close the cover as shown in the 2 and 3 illustration.
- (4) Tear off the paper with the cutter.

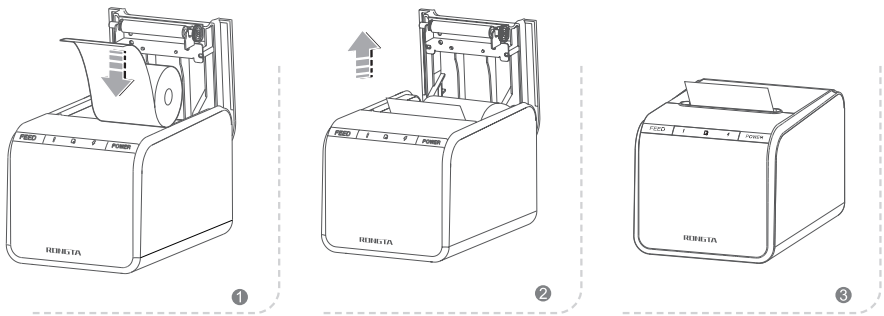

## VI. The Switch, Key and Indicator Light of Printer

---

### 6.1 Power Switch

The power switch controls the flow of power to the printer. The power switch is located on the left side of the printer. When the "-" switch is pressed, the printer is turned on; When the "O" of the switch is pressed, the printer is turned off.

 **Attention: Make sure the power supply is connected before turning on the printer.**

### 6.2 Keys and Indicators

The keys and indicator panel as shown in the following figure:  
The function description of keys and indicators:

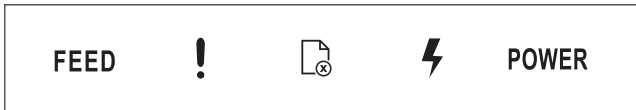

#### **FEED key**

Press the FEED button once to advance paper or hold down the FEED button to feed paper continuously.

Hold down the FEED button and turn on the product at the same time to print the self-test.

#### **POWER indicator (green)**

When connected to the power supply, it always lights up; when connected with WIFI interface, it blinks when not connected successfully; and when connected successfully, it always lights up.

#### **! ERROR indicator (red)**

The ERROR indicator will flashing when occur paper shortage, paper jam, printer head overheating, print head error or other abnormalities.

#### **PAPER indicator (red)**

Paper detection light, the printer is out of paper when the light is on. Once paper is supplied, the light turns off.

### 6.3 Self-Test of Printer

Self-test can detect whether the printer is working normally. If the Self-test list sample can be printed correctly, it indicates that everything is normal except the connection interface with the host computer, otherwise overhaul is required. In the self-test, it will print the software version number, print density, interface type, English characters and some Chinese characters in sequence.

The operation method of self-test is: after the printer is connected, press and hold the feed key first and then turn on the power supply of the printer. First, the printer will reset and detect, and release the feeding button less than 5 seconds after the reset is completed. At this moment, the printer will carry out self-test and print the self-inspection list sample.

### 6.4 Special Functions of Printer

#### WIFI function (alternative)

WiFi is a technology that allows electronic devices to connect to a WLAN. Currently, the company's printers use 2.4G RF frequency band. There is a password for protection for the connection to WLAN; However, it can also be public, thus allowing any device within WLAN range to be connected. For specific WIFI setting steps, please refer to the "WIFI" setting in the integrated tool setting manual.

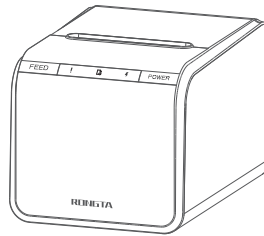

### Bluetooth function (alternative)

Bluetooth is a radio technology that supports short-distance communication of equipment (generally within 10m). It can conduct wireless information exchange among many devices including mobile phones, PDA, wireless headphones, notebook computers, related peripherals, etc. The Bluetooth standard is IEEE802.15, which works in the 2.4GHz band, and the bandwidth is 1 MB/s.



### Paper running out function (alternative)

The paper running out function is to detect the status of the printer's paper bin through the photocoupler sensor, and then display the status through the paper lamp on the printer. The specific display is as follows: if the height of the paper roll in the printer paper bin is greater than the height of the photocoupler, that is, the printer paper roll is large relatively, the paper lamp is off; if the height of the printer paper roll is less than the height of the photocoupler, the paper lamp is always on.

### USB Communication (Alternative)

USB cable is an optional accessory of the printer, which is used to connect the printer to a PC as shown in the figure to charge the printer, set parameters, and transmit data, etc.

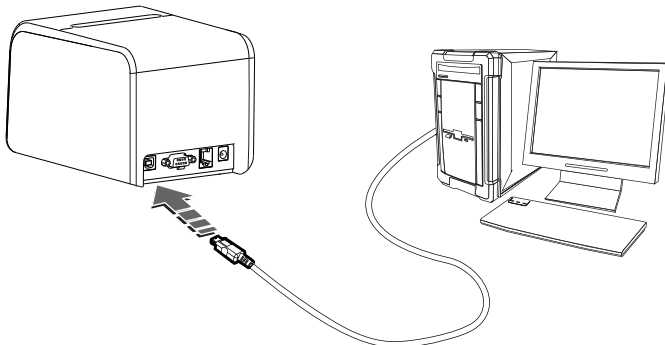

## VII. Serial Interfaces of Printers

The serial interface of ACE G1Y thermal receipt printer adopts RS-232 standard. The communication baud rate is 9600bps, 19200bps, 38400bps or 115200bps optional (adjusting via DIP switch). It is parity-free, 8-bit data bit, 1-bit stop bit; RTS/CTS and XON/XOFF handshake protocols are supported.

**The functions of each pin of the printer serial interface are defined as follows:**

Pin number	Model	Signal source	Description
2	TXD	Printer	The printer sends data to the host.
3	RXD	Host	The printer receives data from the host.
8	RTS	Printer	This signal reflects the current status of printer. A high electrical level indicates that the printer is "busy" and cannot receive data, while a low electrical level indicates that the printer is "ready" and can receive data.
5	GND	-----	Signal ground
6	DTR	Printer	Same as RTS signal (pin 8).

**Schematic diagram of connection between printer serial interface and POS host serial interface:**

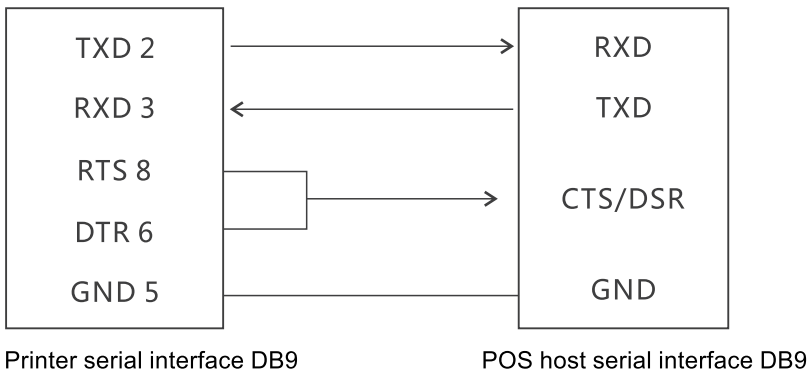

## VIII. Ethernet Interfaces of Printers

The Ethernet interface socket of ACE G1Y series thermal receipt printer is standard RJ45-8P, it supports 10M/100M network, and the transmission speed is adaptive.

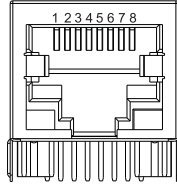

Pin number	Description	Illustration
1	TX+	Send differential line+
2	TX-	Send differential line-
3	RX+	Receive differential line+
4	NC	No function
5	NC	No function
6	RX-	Receive differential line-
7	NC	No function
8	NC	No function

## IX. Cashbox Interfaces of Printers

The cashbox interface of the printer adopts RJ-11 standard, 6-wire socket, and outputs DC 24V/1A power signal to drive the cashbox. Insert the RJ-11 crystal connector of the cashbox into the cashbox interface to open the cashbox through the printer.

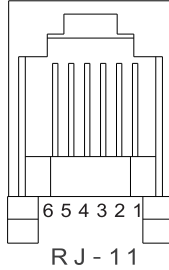

The functions of each pin of the cashbox interface of the printer are defined as follows:

Pin number	Signal	Description
1	NC	—
2	Dk1	Negative pole of cashbox 1#
3	NC	—
4	PWR	Positive pole of power supply/cashbox
5	Dk2	Negative pole of cashbox 2#
6	NC	—

## X. Cleaning the Printer

---

### 10.1 Cleaning the Printer Head

**Clean the print head when one of the following conditions occurs to the printer:**

- (1) Printing is not clear;
- (2) A vertical column of the printed page is not clear;
- (3) The paper feeding noise is high.

**The print head cleaning steps are as follows:**

- (1) Disconnect the power cord, open the upper cover and remove the paper if exists.
- (2) If printing has just been completed, wait for the print head to cool completely;
- (3) Clean the printer head with a soft cotton moistened with ethyl alcohol.
- (4) After waiting for absolute ethyl alcohol to volatilize completely, close the cover and try printing again.

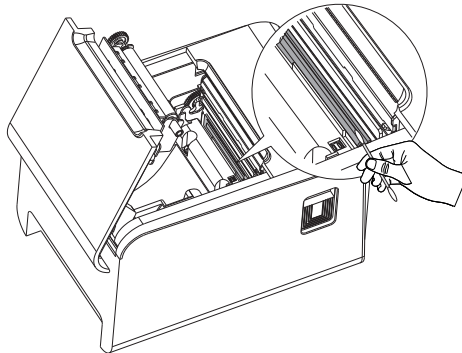

### 10.2 Cleaning the Sensor

**Clean the paper shortage sensor when one of the following conditions occurs to the printer:**

- (1) In the printing process, the printer occasionally stops printing and alarms for paper shortage;
- (2) It does not give alarms for paper shortage.

**The paper shortage sensor cleaning steps are as follows:**

- (1) Turn off the power supply of the printer, open the upper cover, and remove the paper if there is any;
- (2) Wipe off the dust and stain on the sensor surface with soft cotton cloth (which should be dried) dipped in absolute ethyl alcohol.
- (3) After waiting for absolute ethyl alcohol to volatilize completely, close the cover and try to start the machine again.



## 10.3 Cleaning the Printing Rubber Roller

When one of the following conditions occurs to the printer, the printing rubber roller should be cleaned:

- (1) Printing is not clear;
- (2) A vertical column of the printed page is not clear;
- (3) The paper feeding noise is high.

The printing Rubber Rollers cleaning steps are as follows:

- (1) Turn off the power of the printer and open the upper cover;
- (2) Use a soft cotton cloth (which should be dried) dipped in a neutral detergent to wipe off dust and stains on the surface of the printing rubber roller;
- (3) Close the upper cover after the cleaning agent is completely volatilized.

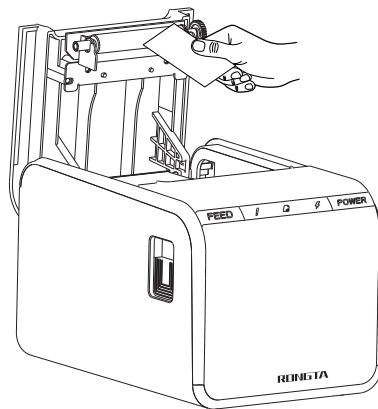

### Attention:

- (1) The power supply must be turned off during the daily maintenance of the printer.
- (2) Do not touch the surface of the print head with hands and metal objects, and do not scratch the surface of the print head, printing rubber roller and sensor with tweezers and other tools.
- (3) The organic solvents such as gasoline and acetone shall not be used.
- (4) Wait until absolute ethyl alcohol is completely volatilized, then turn on the power supply to continue printing.

## XI. Release the Jammed knife

---

When the knife of printer is jammed, the upper cover of the printer cannot be opened. The printer shall be powered off and restarted. If the jammed knife is not reset, the power supply of the printer shall be turned off, the front cover of the printer (as shown in the left figure) is opened, and the jammed knife can be released by reversing the gear.

**(The gear is in the position as shown in the following figure)**

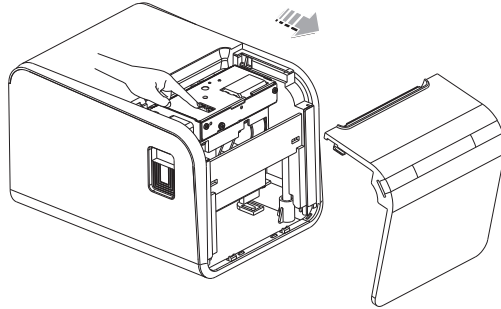

## XII. Troubleshooting

When the printer fails, it can be handled according to the method in this section. If the problem cannot be solved, please contact the distributor or manufacturer.

### 12.1 The indicator on the control panel is not on

Check whether the power cord is properly plugged into the printer, power adapter, and power outlet or not. Check if the printer's power switch is on.

### 12.2 The indicator is normal, while the printer does not work

Run the self-test to check whether the printer can work properly. If you cannot perform self-test, please contact your distributor or the technical service personnel.

**If the self-test can be performed normally, check the following:**

- (1) Check the interfaces at both ends of the connection line between the printer and the computer. At the same time, confirm whether the connection meets the specifications of printer and computer.
- (2) The data transfer settings between the printer and the computer may be different. You can use self-test to print out the printer's interface settings. If the printer cannot print, please contact your distributor or the technical service personnel.

## **XIII. Driver Installation**

---

---

There are two ways to drive the ACE G1Y thermal receipt printer, one is to install the driver directly under Windows 9X/7/8/10/ME/2000/XP, the other is to use the port for direct driving.

### **13.1 Installation for Windows**

Add the printer to Windows and assign the driver files in the driver disk to Windows. You can start printing only by calling the print command in the program. In this way, the printer driver of Windows actually converts characters into graphic dot matrix for printing.

### **13.2 The Port direct drive**

In this way, there is no need to use a driver, only the characters need to be directly output to the port, and the built-in and cartridge font inside the printer is used to realize the conversion and printing of the characters. Using the port direct drive way, the printing mode is also changed from page printing mode to line printing mode, making printing control more convenient. If the port direct drive mode is used, the instruction set needs shall be used to control the printing of the printer, and the ESC/POS command set has been integrated inside the ACE G1Y series thermal receipt printer.



**Rongta Technology (Xiamen) Group Co., Ltd.**

**ADD: No. 889 Xinmin Avenue, Tongan District, Xiamen, China**

**WEB: [www.rongtatech.com](http://www.rongtatech.com)**

**TEL: 0086-592-5666129    FAX: 0086-592-5659169**

